

EY-RU 341...346: Room operating unit, ecoUnit341...346

How energy efficiency is improved

Individual setting of presence and absence as well as room setpoint correction and control of lighting and window blinds for optimum energy usage in the room. Visualisation of the local energy consumption by means of multicolour LED indicator

Features

- Part of the SAUTER EY-modulo 5 system family
- Room operating unit for ecos500, 502, 504, 505
- Can be extended with EY-SU 306 switching unit
- Temperature measurement and setpoint adjustment
- Display with extensive status information on room conditions
- Multicolour LED indicator for visualisation of local energy consumption
- Device insert with transparent front, fits into frame with 55 x 55 mm aperture
- Frame can be ordered as an accessory
- Room climate can be adapted individually
- Operating mode can be set for room occupancy and actuation of a 3-speed fan
- Control of window blinds, windows and lighting (ON/OFF, dim)
- Room operating unit with a wide range of functions, designs and colours



EY-RU346F001

Technical data

Power supply

Power supply	From automation station
Current consumption	≤ 8 mA, ≤ 20 mA with 2 × EY-SU 306

Ambient conditions

Operating temperature	0...45 °C
Storage and transport temperature	-25...70 °C
Admissible ambient humidity	10...85% rh, no condensation

Parameters

Sensors	Measuring range	0...40 °C
	Resolution	0.1 K
	Time constant	Approx. 7 minutes
	Measuring accuracy	Typ. 1 K in the 15...35°C range
Functionality	Setpoint correction	Adjustable and resettable
	Room occupancy (presence)	3 modes, LCD
	Fan speeds	5 functions, LCD
	Position LED	Switchable: green/red/OFF

Interfaces and communication

Connection to automation station	Activation	ecos 5
	Interface	RS-485
	Protocol	SLC
	Line	4-wire, twisted, shielded
	Cable length ¹⁾	≤ 100 m (30 m) with bus termination
	Connection terminals	Pluggable for wire of 0.12...0.5 mm ² (Ø 0.4...0.8 mm)

Construction

Fitting	Recessed/surface-mounted (see accessories)
Dimensions W x H x D	59.5 × 59.5 × 25 mm
Weight	0.1 kg
Housing	Pure white (similar to RAL 9010)
Labelling insert	Silver (similar to Pantone 877 C)

¹⁾ Max. 30 m for industrial applications as per EN 61000-6-2



Standards and directives

	Type of protection	IP30 (EN 60529)
	Protection class	III (EN 60730-1)
	Environment class	3K3 (IEC 60721)
CE conformity according to	EMC Directive 2014/30/EU	EN 61000-6-1, EN 61000-6-2, EN 61000-6-3, EN 61000-6-4

Overview of types

Type	Features	Buttons
EY-RU341F001	Operating unit with LCD, NTC sensor, dXs set-point correction	2
EY-RU344F001	Operating unit with LCD, NTC sensor, dXs set-point correction, fan, occupancy	4
EY-RU346F001	Operating unit with LCD, NTC sensor, dXs set-point correction, fan, occupancy, window blinds, lighting	6

Accessories

Type	Description
EY-SU306F001	Push-button unit, without frame

Fitting

Type	Description
0940240***	Frames, mounting plates and adaptors for third-party frames: see product data sheet PDS 94.056
0949241301	Transparent cover for EY-RU 310 (10 pcs.)
0949360004	Plug-in connectors ecoUnit, 2-pin, "01/02", "03/04" (2 x 10 pcs.)

Description of operation

The ecoUnit 3 room operating units EY-RU 341...346 measure the room temperature and have buttons for setpoint correction, to select the presence mode and the fan speed and up to two freely allocatable buttons.

The room operating units belong to the ecos 5 product family and can be connected to a (room) automation station (RC/AS) of the EY-modulo 5 system family using the digital RS485 connection. The LCD can be controlled using the room controller.

Intended use

This product is only suitable for the purpose intended by the manufacturer, as described in the "Description of operation" section.

All related product regulations must also be adhered to. Changing or converting the product is not admissible.

Front view and labelling inserts

Depending on the type of device, different labelling inserts are included. The operating unit can be adapted to the spatial conditions.

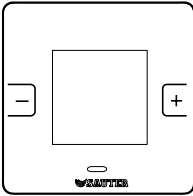
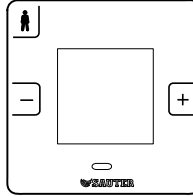
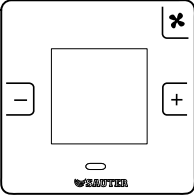
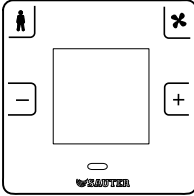
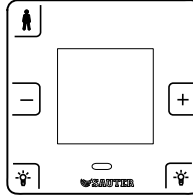
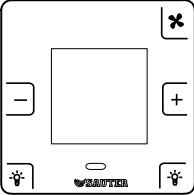
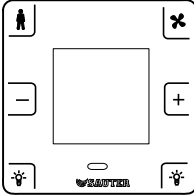
Type	Labelling inserts included in the scope of delivery		
EY-RU 341			
EY-RU 344			
EY-RU 346			

Engineering notes

Fitting

The EY-RU 341...346 room operating units are suitable for various fitting methods. Product data sheet PDS 94.055 shows the mounting options and the accessory material required.

The EY-SU 306 switching unit can be used to enhance the EY-RU 341...346 room operating units with 6 additional button functions.

EY-SU 306 is connected to EY-RU 341...346 with a 2-core connection and can only be used in conjunction with this device.

Two EY-SU 306s with the same button assignment/function can be connected in parallel. Switching unit EY-SU 306 can be installed up to 30 m (total line length) away from the EY-RU.

Connection to automation station

The room operating units are connected to the AS with a 4-wire shielded cable with twisted wire pairs. The max. admissible bus length depends on the cable type used and the correct termination with terminating resistors. Observe the correct polarity of all signals. The wire shield of the entire bus line must be connected continuously, and connected to the protective earth as directly as possible (max. 8 cm) at one location, for optimum resistance to interference.

For Ethernet CAT-5 cables, as well as IYST-Y cables, a bus length of up to 100 m is possible, for applications in residential, business and commercial areas (interference resistance requirements as per EN61000-6-1). Applications in industrial areas (interference resistance requirements as per EN61000-6-2) allow a max. total bus cable length of 30 m.

In the case of RS485 interfaces, the bus wiring must follow line topology. Star, tree or branch topologies are not recommended. The devices do not have internal terminating resistors. Therefore, a terminating resistor of 120 Ω (0.25 W) must be connected at the start and end of the bus line, parallel to the D+/D- data lines.

Addressing the operating units

A device address must be set on the communicative room operating units to ensure that they can be contacted by the automation station.

The housing cover of the ecoUnit is located under the transparent cover or the labelling insert. All operation and indication functions are clearly labelled on this surface.

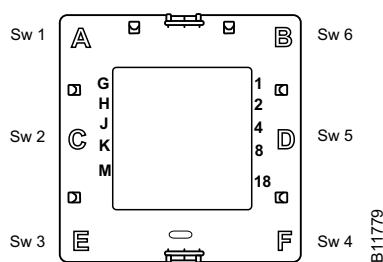

Sw: Connection name in firmware module.

At least 2 buttons are available on all variants: Top left button (A) and top right button (B). On EY-RU 341 devices, these two buttons or LEDs can only be used for addressing.

Addressing mode

The device address can be set without a time restriction after switching on if:

- no address has previously been assigned to it (ex works condition) or
- there is no communication with the AS, for example because addressing has been carried out incorrectly.

The addressing mode is signalled using the bi-colour position LED which is located under the LCD. The LED state during addressing mode overwrites the LED state requested by the user program of the AS.

The following applies:

Position LED	Status	Meaning
Red	Flashing	Device is not addressed
Red	Constantly ON	Device is in addressing mode (temporary)
Green	Flashing	Valid address is displayed (temporary, approx. 10 s)
Green, red	Constantly ON or OFF	Device in operation, see position LED

Non-addressed device, set address

In ex works condition, the devices are not addressed, the position LED flashes red after powering up. If button (B) is pressed for over 5 seconds, the device switches to addressing mode and the position LED is lit red continuously. The address 0 is displayed, pressing button (B) again activates the input mode. The device address (1 to 4) can now be set, represented by the last digit in the display. In this mode, the digit flashes.

Addresses 0 and 5...15 are currently not supported by the automation stations. The address is scanned upwards using button (B) and downwards again using button (A). Pressing and holding button (A) stores the setting and returns to operating mode. However, if no change is made for 5 seconds, the device returns to the operating mode without saving the settings that have been carried out.

Changing addressed devices

The position LED is lit continuously green, red or OFF according to the AS user program.

If button (B) is pressed for over 5 seconds within the first minute after voltage is restored, the device switches to addressing mode and the set address is displayed. If button (B) is pressed again, the device switches to input mode. The address is scanned upwards using button (B) and downwards again using button (A).

Pressing and holding button (A) stores a new address and returns to operating mode.

However, if no change is made for 5 seconds, the device returns to the operating mode without saving the settings that have been carried out.

Error messages on the LCD

Err2: No communication to the automation station

Cause:

- Communication lines are not correctly installed
- Incorrectly engineered, e.g. "ROOM UNIT" module not used
- Automation station has not yet started up completely

Position LED

For devices starting from index C, the state of the position LED can be set using the user programs of the AS: continuously green, red or OFF. For example, this function can be used to indicate optimal energy consumption in the room by the colour green. The colour red can be used in the same way in

order to indicate energy consumption that is too high. This function is not available for devices up to and including index B.

Connecting EY-RU 3 ** to the user program of the automation station

How the automation station or the operating unit and display respond to the press of a button is programmed in the user program. The "ROOM UNIT" module is available in the firmware for this purpose. This module is described in the "Firmware modules" documentation.

Resetting the setpoint correction

This feature is available from device index E of the EY-RU34*. Operators of energy efficiency of buildings often want to be able to centrally reset the local setpoint correction made by room users at regular intervals, for example using a building management system. The setpoint correction can be reset using the "X2" input on the ROOM_UNIT firmware module (CASE Engine) and affects the display of the room operating unit (numeric value and bargraph) as well as the corresponding "Offset" output of the "ROOM_UNIT" module. The illustration below shows an example application:

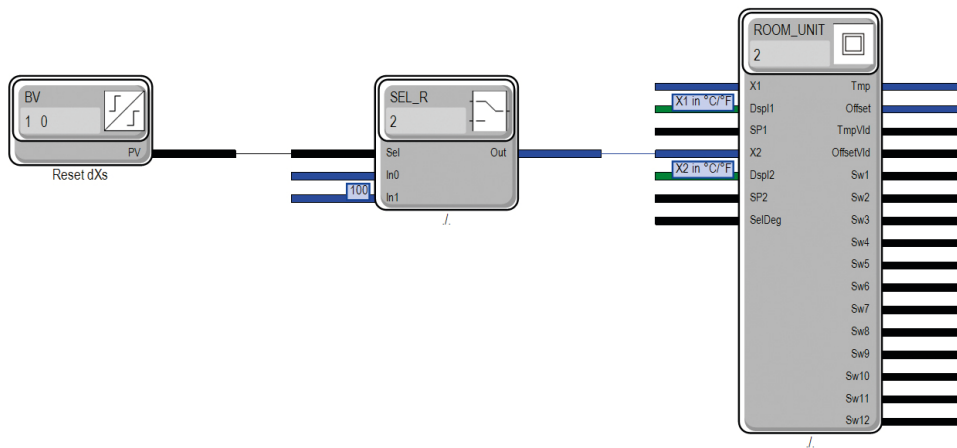

The assignment of the input value at "X2" to the function is as follows:

- Value < 100: Setpoint correction "dXs" is not affected.
User can change dXs on the room operating units.
- Value ≥ 100: Setpoint correction "dXs" is set to 0.

Resetting the setpoint correction only works if the "Dsp12" input is set to "X2 in °C/F". It is advisable to only apply the reset signal for dXs for a short time, for example 1 second, so that users can then adjust the setpoint as required afterwards. In the illustrated example application for CASE Engine "Reset dXs", a selector module with binary activation is used for this. Resetting is possible via the BMS system using the binary value object "Reset dXs".

Display functions

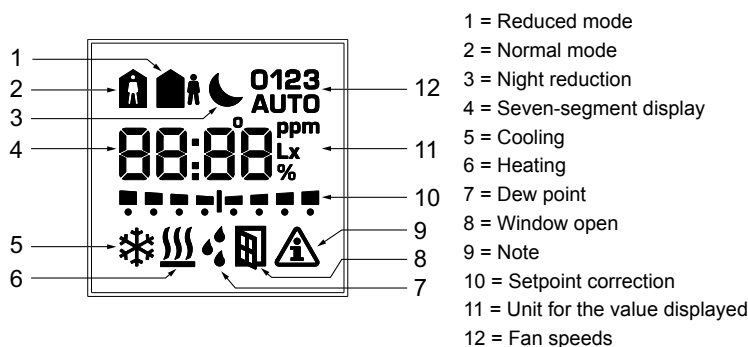

Additional information

Fitting instructions	P100001966
Declaration on materials and the environment	MD 94.040

Dimension drawing	M10501
Connection diagram	A10523

Disposal

When disposing of the product, observe the currently applicable local laws.

More information on materials can be found in the Declaration on materials and the environment for this product.

Connection diagram for EY-RC 500 (RS485A), 502, 504, 505, EY-AS 521

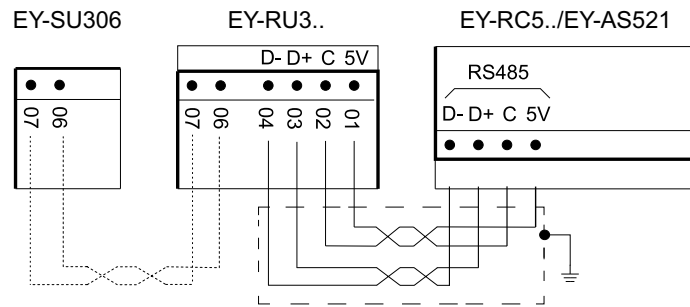

RS-485 bus wiring

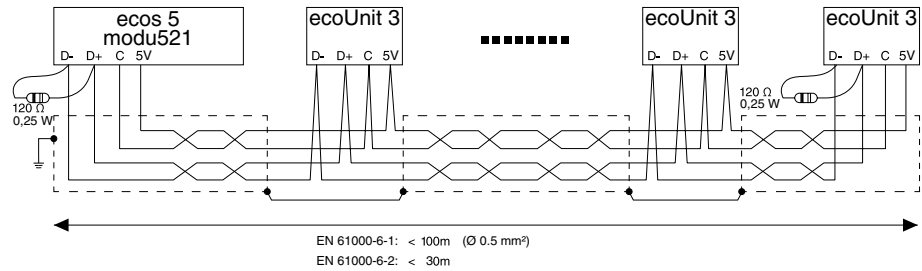

For industrial applications, the entire bus length may be max. 30 m to fulfil the criteria for interference resistance as per EN-61000-6-2. For residential, business and commercial applications with requirements as per EN61000-6-1, the entire bus length may be up to 100 m.

Dimension drawing

